

In Between ^{SK1 & SK2}

Sami Kallio

2013

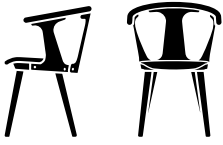



SK2

Recycling & Disassembly

In Between SK1 & SK2

RECYLING

The In Between chair is built to last, and we hope that your In Between will serve you for many years. The chair is made from solid wood and wood veneer, and can be easily separated from its base. All metal and wooden parts can be separated and delivered to a suitable recycling station.

SPARE PARTS

To purchase spare parts for your In Between chair, please write to our sales support team at info@andtradition.com with your query.

5 YEAR WARRANTY

&Tradition provides a 5-year warranty with every In Between chair, which covers faults which were present at the time of purchase, or which have occurred as a result of a manufacturing defect. The warranty is valid from the date stated on the original invoice.

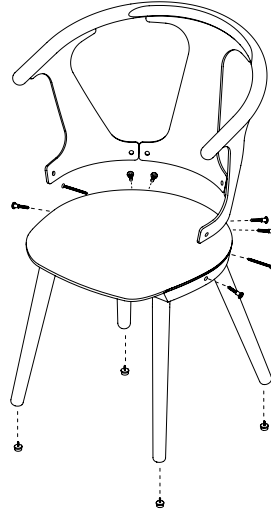

DISASSEMBLY

Disassembling of In Between chair

1. To disassemble the In Between chair use an Allen key to loosen the screws holding the veneer panel in place.
2. Remove the veneer panel and unscrew the two screws located at the back of the seat.
3. Remove the gliders.

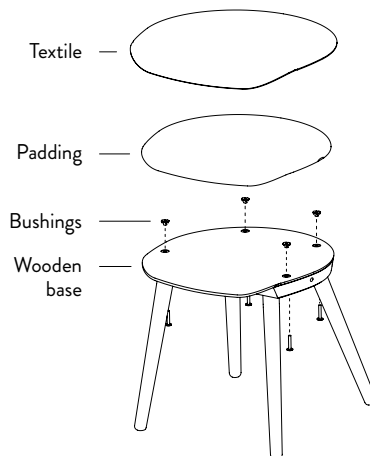

Disassembling of upholstered seat (SK2 only)

1. Unscrew the screws underneath the seat and remove the textile, padding and bushing from the wooden base of the seat.
2. Remove the textile, padding and bushing from the wooden base of the seat.

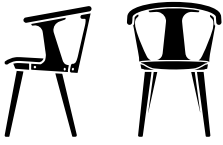

SK1

In Between ^{SK1} Sami Kallio 2013

Product category
Chair

Environment
Indoor

Production process
The legs and the armrest are turned from solid oak and the seat and side panels are formpressed from oak or ash veneer.

Material
Solid wood and formpressed veneer.
This product has not been treated with any biocides.

Wood finishes
Oiled oak
Smoked oiled oak
Black lacquered oak
Oiled walnut

Certifications
FSC Mix (C154398): Oiled Oak, Smoked Oiled Oak, Black Lacquered Oak



Strength, Durability and Safety Testing
The chair is tested for strength, durability and safety according to EN 15373 Level 2 - General contract use.

Related products



SK2 SK7 & SK8 SK9 & SK10

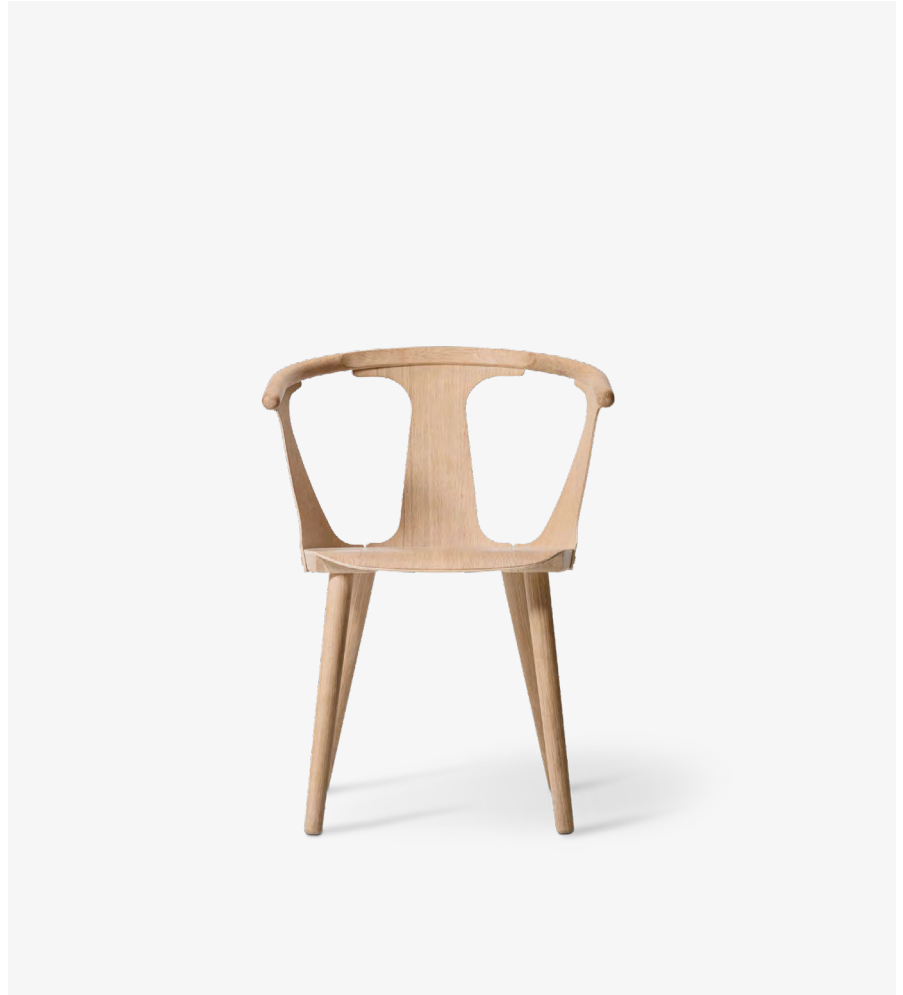

Dimensions

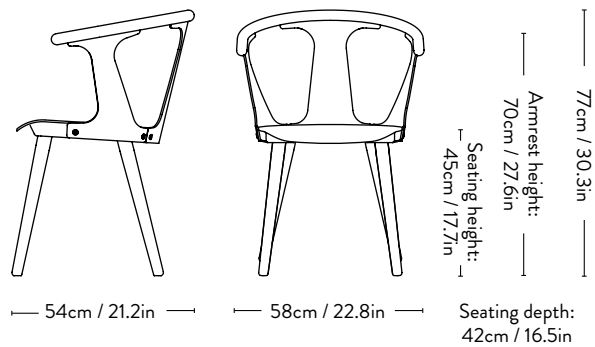

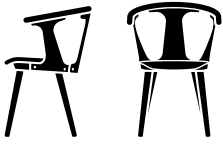

SK1

In Between ^{SK1} Sami Kallio 2013

Package dimensions

H: 95.0cm / 37.4in

W: 72.0cm / 28.3in

D: 60cm / 23.6in

Colli quantity

2

Weight

Product: 7.0 kg / Incl. packaging: 14.5 kg

Gliders

Felt gliders installed as standard.

Manufacturer

Produced in Latvia by Kvist Industries A/S

Cleaning Instructions

Please click [here](#) to download our Material Care & Cleaning Instructions.

Wood finishes



Oiled oak

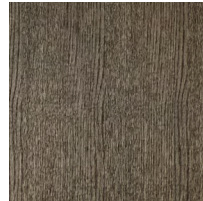

Smoked oiled oak



Black lacquered oak

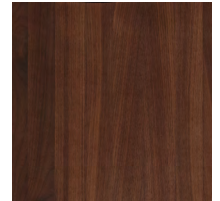

Oiled walnut

Stock item

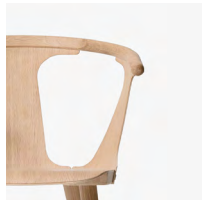

Oiled oak

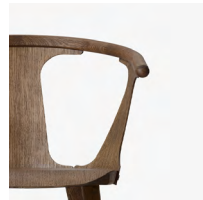

Smoked oiled oak



Black lacquered oak

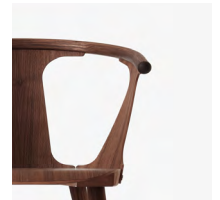

Oiled walnut

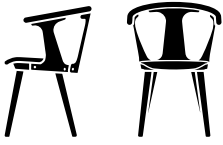

SK2

In Between ^{SK2} Sami Kallio 2013

Product category
Chair

Environment
Indoor

Production process
The legs and the armrest are turned from solid oak and the seat and side panels are formpressed from oak or ash veneer.

Material
Solid wood, formpressed veneer, HR foam, fabric or leather upholstery.
This product has not been treated with any biocides.

Wood finishes
Oiled oak
Smoked oiled oak
Black lacquered oak
Oiled walnut

Certifications
FSC Mix (C154398): Oiled Oak, Smoked Oiled Oak, Black Lacquered Oak



Strength, Durability and Safety Testing
The chair is tested for strength, durability and safety according to EN 16139 Level 1 - General contract use.

Related products



SK1 SK7 & SK8 SK9 & SK10



Dimensions

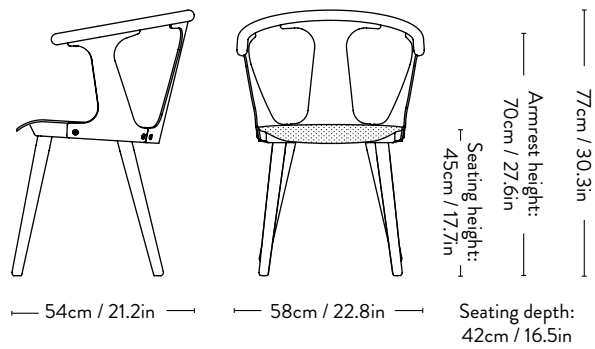

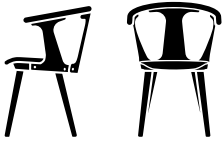

SK2

In Between ^{SK2} Sami Kallio 2013

Package dimensions

H: 80.0cm / 31.5in
W: 56.0cm / 22in
D: 59cm / 23.2in

Colli quantity

2

Weight

Product: 7.0 kg / Incl. packaging: 14.5 kg

Gliders

Felt gliders installed as standard.

COM - Material Consumption

Fabric usage: 0.36 meter based on a 140 cm roll.
Leather usage: 0.36 sqm.
COM must be approved by &tradition to ensure suitability for upholstery on the chair.

Manufacturer

Produced in Latvia by Kvist Industries A/S

Cleaning Instructions

Please click [here](#) to download our Material Care & Cleaning Instructions.

Wood finishes



Oiled oak



Smoked oiled oak



Black lacquered oak



Oiled walnut

Stock item

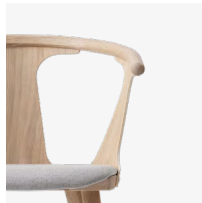

Oiled oak
w. Fiord 251

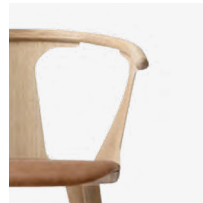

Oiled oak
w. Cognac silk leather

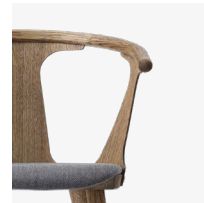

Smoked oiled oak
w. Fiord 171

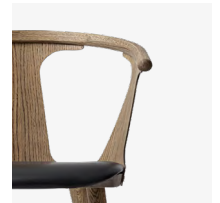

Smoked oiled oak
w. Black silk leather

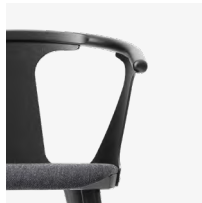

Black Lacquered oak
w. Fiord 191



Black Lacquered oak
w. Black silk leather

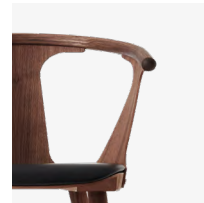

Oiled walnut
w. Black silk leather

* All other fabrics or leathers available with a lead time of 6-8 weeks.