

Instructions

Formakami JH18

Jaime Hayon

2018

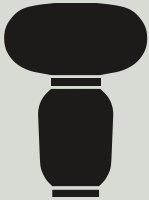

Congratulations with your new Formakami lamp, designed in 2018 by Jaime Hayon. We hope you will enjoy using this product and follow these instructions to ensure correct installation. If you have any questions or comments, please do not hesitate to contact us by mail at: info@andtradition.com

&Tradition®

Formakami JH18

Jaime Hayon

2018

Please read these instructions carefully and retain them for future reference to ensure that the product is used correctly. For your own safety, please study each step of this instruction manual first. &Tradition is not responsible for any faults or damages caused by not following these instructions correctly. Do not modify this product in any way.

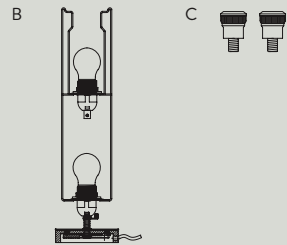
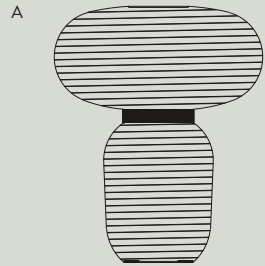

Contents

- A Paper shade
- B Lamp base with 2 meter cable and dimmer
- C 2 x Screws

Safety precautions

- Dispose of plastic bag from packaging and do not allow children to play with it.
- Keep product well out of children's reach.
- The product is only intended for interior use.
- Do not attempt installation of product if you are not competent to do so yourself.
- Consult a professionally qualified electrician if in any doubt.
- Disconnect the electricity supply at the fuse box, before commencing work.
- If the external cable or cord of this lamp is damaged, it must be replaced by the manufacture or a similar qualified person in order to avoid a hazard.

Cleaning instructions

- Wipe surface of lamp shade with a soft duster, or very gently with a soft dry cloth.
- Do not use any abrasive cleaning tools such as steel wool, scouring sponges or stiff brushes.
- Never use liquids to clean the shade.

For indoor use only
E27 maxium 60 W
Bulb Not included

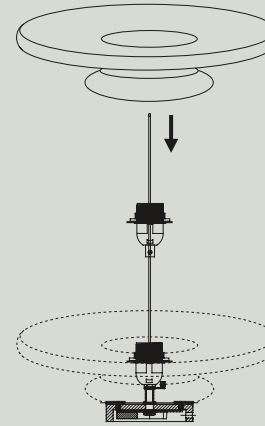

Step 1

Carefully lower the lamp shade onto the lamp base.

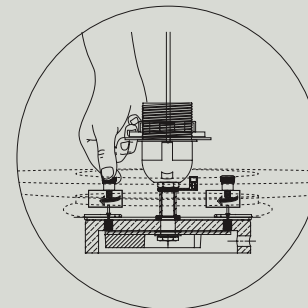

Step 2

Align the holes from the paper shade's wire frame with the holes in the wooden base. Insert the screws and tighten them by hand.

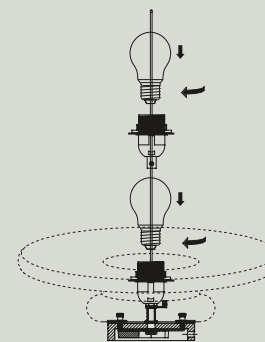

Step 3

Install the light bulbs.



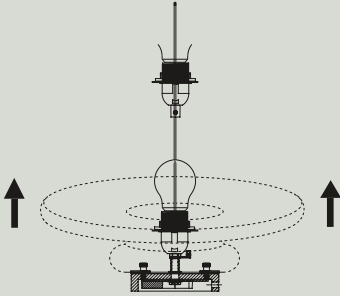

Step 4

Carefully pull the paper shade up over the lamp base.

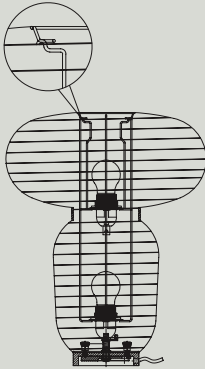

Step 5

Connect the top of the paper shade with the wire frame of the lamp base.

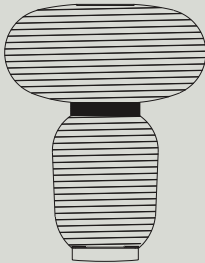

Step 6

The lamp is now ready to use. The light intensity can be adjusted using the dimmer switch in the cable.